



## SAFETY WARNINGS & INSTRUCTIONS MODEL: TETHRD ONE STICKS GEN 1

### Contents

- Pg. 2** Safety Warnings
- Pg. 4** Attaching the Climbing Stick to the Tree
- Pg. 6** Stacking the Climbing Stick
- Pg. 7** Troubleshooting  
Warranty

## WARNING

Hunting from an elevated position is dangerous and risky.

Do not attempt to climb off the ground without understanding the safety risks.

Failure to follow and understand all directions and watch all instructional videos could result in injury or death.

This guide does not replace proper instruction by a qualified professional.

You are responsible for your own actions and decisions.

Always know the history and maintenance of your climbing equipment.  
The use of secondhand equipment is discouraged.

## WARNING

- **DO NOT** use TETHRD® products without reading all safety warnings and directions.
- **DO NOT** use TETHRD® products until you have watched ALL directional videos and warnings at [www.YouTube.com/TethrdNation](http://www.YouTube.com/TethrdNation) or [www.TethrdNation.com](http://www.TethrdNation.com)
- **DO NOT** use TETHRD® products until you have practiced on the ground with all your equipment and are 100% confident with the system.
- **DO NOT** use TETHRD® products until you have practiced in the dark to prepare for a hunting scenario.
- **DO NOT** ascend or descend a tree in the dark without a hands free light (like a head lamp).
- **DO NOT** use TETHRD® products without first inspecting them for damage or excessive wear.
- **DO NOT** use any safety products (ropes, carabiners, etc.) that are not climbing rated.
- **DO NOT** ascend or descend a tree with climbing methods that are untested or unrated.
- **DO NOT** ascend or descend a tree without being connected to the trunk at all times.
- **DO NOT** climb on the Predator platform or any other positioning aid without being connected to the tree with both your tether and lineman belt.
- **DO NOT** remove your lineman belt for any reason while climbing until you are safely connected to the tree with your tree tether or full body safety harness.
- **DO NOT** allow slack in your lineman belt or tree tether. They are to remain taut at all times.
- **DO NOT** climb above your lineman belt. It must always be above waist level.
- **DO NOT** use your your lineman belt, tether, or UtiliBridge without a stopper knot tied in the free end.
- **DO NOT** exceed the total weight limit of TETHRD® products. Total weight includes yourself and gear. Exceeding the total weight limit can result in serious injury or death.

### PRACTICE

Practice using the TETHRD® climbing sticks in a safe environment at least 5 times in the daylight and at least 2 times in the dark before using it in a hunting scenario. Under no circumstances shall you use this or any other climbing method without practicing your system in a safe environment.

### SAFETY PLAN

- If the hunting location is unknown by anyone and communication efforts are unsuccessful, you must have a personal plan for recovery/escape because prolonged suspension in a harness can be fatal. It is important to exercise the legs by pushing against the tree or doing other forms of continuous leg exercises to avoid blood pooling while being suspended. Hunters with varying degrees of physical fitness may require different plans to recover/escape the effects of prolonged suspension. Have a personal plan and practice it in the presence of a responsible adult before leaving the ground. No one escape/rescue plan will work for every hunter on every tree in every circumstance. Only you can determine the best recovery/escape plan for your hunting situation and you must have a recovery/escape plan for your situation before leaving the ground.

- A suspension relief device must be on your person and readily accessible while using a harness. These devices allow the user to relieve the load on the lower extremities if suspended in a harness and help maintain circulation in the legs, mitigate suspension trauma (blood pooling) or allow descent to the ground. Be sure to follow the manufacturers' directions on the safe use of any suspension relief device.

- Hunt from the ground when self-recovery/escape ability is absent or if you do not have all necessary components of your saddle and platform.
- There is time to make a correct decision on what action to take if an unforeseen event takes place. It is important to remember, "DO NOT PANIC." Remain calm and implement your practiced rescue, relief, and recovery plan.

### GENERAL SAFETY INSTRUCTIONS

- **NEVER** use climbing sticks while taking drugs (even prescription drugs) or alcohol.
- **NEVER** use climbing sticks during inclement weather such as rain, lightning, windstorms, or icy conditions and end your hunt and return to the ground if inclement conditions arise.
- **NEVER** use climbing sticks when feeling ill, nauseous or dizzy, or if you have a prior medical condition that could cause a problem i.e., heart condition, joints that lock - up, spinal fusions, etc. or if you are not well rested. You **MUST** be physically and mentally able to recover to your platform, climbing aid, or ground in the event of a fall.
- **NEVER** use climbing sticks on a dead, leaning, diseased or loose barked tree or on a utility pole.
- **NEVER** rely on a tree branch for support.
- **NEVER** jump or bounce on climbing sticks to seat it to the tree.
- **ALWAYS** pull up a bow, backpack, firearm or other equipment only after being securely connected to the tree with your tether and harness. A firearm must be pulled up with it unloaded, chamber open and muzzle down.
- **ALWAYS** inform someone of the hunting location, where you will be located and the expected duration of the hunt.
- **ALWAYS** carry a signal device such a mobile phone, radio, whistles, signal flare or personal locator device (PLD) on your person and readily available at all times.
- **ALWAYS** inspect the climbing sticks and all safety devices each time before use and do not store climbing sticks outdoors when not in use.
- **NEVER** modify your climbing sticks in any way by making repairs, replacing parts, or altering adding or attaching anything to it except if explicitly authorized in writing by the manufacturer.
- **NEVER** leave climbing sticks in the tree. Weather, animals, or tree growth could cause damage.
- **ALWAYS** use a haul line to raise and lower all your hunting gear. Never climb with anything on your back.
- **ALWAYS** climb with proper fitting boots with appropriate tread. Boots should have a non-slip sole that grips well. Always tuck your laces inside your boot or pants so the laces do not snag on the climbing stick, limbs, or other obstacles.
- Sectional ladders and steps should be spaced on the tree to insure each step is no more than 18 inches apart.
- Climbing aids (climbing sticks, sectional ladders, steps, etc.) must extend above the platform to allow the user to step down onto the platform. Never step up to your platform from a climbing aid.
- Instructions (written and video) shall be kept in a safe place and reviewed at least annually. It is the responsibility of the saddle or platform owner to furnish the complete instructions to any person that borrows or purchases the climbing sticks.

**If there are any questions, DO NOT use the product and contact TETHRD® for support:**

**Phone: (612) 605-7782**

**Email: [hello@tethrdnation.com](mailto:hello@tethrdnation.com).**

# INSTRUCTIONS - SAFETY WARNING – READ BEFORE USE

## WARNING

For hunting from an elevated position only. Hunting above the ground is dangerous. Understand and accept the risks involved before participating. You are responsible for your own actions and decisions. Before using this product, read and understand all instructions and warnings that accompany it and familiarize yourself with its capabilities and limitations. We recommend that every hunter seek qualified instruction before use. Failure to respect any of these warnings can result in severe injury or death!

When hunting from an elevated position, falls can occur any time after leaving the ground causing injury or death.

THIS PRODUCT DOES NOT COME WITH A TETHRD® SADDLE OR A FULL BODY HARNESS.

A full body harness that meets the requirements of ASTM F2337 is an integral part of the climbing stick system. This product is never intended to be used without a harness with lineman's climbing belt. Full Body Harnesses are provided with those stands that have been certified by a Third Party Testing Facility to meet or exceed industry standards, and are available as after market purchases. Never use without wearing a TETHRD® Saddle or a full body harness with lineman's climbing belt that meets or exceeds industry standards, and ensuring a TETHRD® Saddle or a full body harness is attached to the tree at all times after leaving the ground. A double connection to a TETHRD® Saddle or Full Body harness using a lineman's climbing belt and tree tether is strongly recommended while climbing a tree and before stepping onto a treestand after desired height has been reached. This double connection method is explained more thoroughly in the TETHRD® Saddle or full body harness instructions. You must read and follow those instructions. Failure to do so may result in serious injury or death. If a TETHRD® Saddle or a full body harness with lineman's climbing belt is unavailable, do not install or use this product. Single safety belts and chest harnesses are no longer allowed and should never be used.

Always wear fall arrest system (FAS) comprising of TETHRD® Saddle or full body harness that meets the requirements of ASTM F2337 and lineman's climbing belt at all times after leaving the ground. You must remain connected to tree at all times after leaving the ground while using this product.

Only use this product with treestands that have been certified by a Third Party Testing Facility to meet or exceed industry standards.

Inspect climbing sticks, treestand, and all safety devices each time before use for any damage, including but not limited to corrosion, wear, damage, deterioration, vandalism, fraying or other damage. DO NOT USE THIS PRODUCT OR ANY ELEVATED HUNTING TOOL if damage is visible or suspected. If there are any questions, DO NOT use the product and contact TETHRD® at (612) 605-7782 or email support at [hello@tethrdnation.com](mailto:hello@tethrdnation.com).

**FAILURE TO FOLLOW THESE INSTRUCTIONS CAN RESULT IN SERIOUS INJURY OR DEATH!**

### BEFORE USING YOUR CLIMBING STICKS

Read all warnings, instructions, and watch all instructional videos at [www.tethrdnation.com](http://www.tethrdnation.com) before using your climbing sticks. Learn how to attach the climbing sticks to the tree while safely on the ground before attempting to climb above the ground. Learn how to use the climbing sticks in conjunction with a TETHRD® Saddle or a full body harness with lineman's climbing belt that meets the requirement of ASTM F2337.

### WARNING

- In climbing and hunting there is no substitute for experience. If you lack experience, hunt and use your climbing sticks only under the guidance of a properly trained individual.
- Attaching your climbing sticks requires your absolute attention. Establish a routine. Complete every action, double-check all ropes, connections, and knots, and avoid distractions. During use, frequently double-check that your lineman's climbing belt is correctly connected to your TETHRD® Saddle or full body harness.
- We strongly discourage acquiring second hand equipment. In order to fully trust your gear you must know its history of use.

### CHOOSING OTHER COMPONENTS

These climbing sticks must be used in conjunction with TETHRD® approved equipment. Do not alter the climbing sticks in any way. Alterations may cause injury or death.

### STORAGE AND TRANSPORT

- Store all of your gear in a clean and dry environment, out of direct sunlight and away from heat sources.
- Keep your equipment away from gnawing rodents and pets.

### INSPECTION AND RETIREMENT

- This product contains no user serviceable parts except for the DynaLITE™ ropes and StickLoc™ pins. Replace ropes every two (2) years from purchase date or sooner if damage including but not limited to wear, deterioration, corrosion, cuts, tears, rot, etc. or vandalism is visible or suspected. Failure to do so can result in serious injury or death. Replace StickLoc pins™ as needed.
- Use only TETHRD® authorized replacement parts. The use of unauthorized replacement parts may result in serious injury or death.
- Proper maintenance and inspection is required for this product.
- This product is used to support you at height. Never use a climbing stick that is damaged in any way. Do not use climbing stick if it is not wholly free of damage. If you have questions, contact TETHRD® at (612) 605-7782 or email support at [hello@tethrdnation.com](mailto:hello@tethrdnation.com).

- Before every use, inspect climbing sticks, treestand, harnesses, saddles, and all safety devices for damage including but not limited to corrosion, wear, damage, deterioration, rot, cracks, vandalism, fraying or other damage.
- DO NOT USE THIS PRODUCT OR ANY ELEVATED HUNTING TOOL if damage is visible or suspected. If there are any questions, DO NOT use the product and contact TETHRD® at (612) 605-7782 or email support at [hello@tethrdnation.com](mailto:hello@tethrdnation.com)
- Failure to follow these instructions can lead to serious injury or death.

For more information on Rope Inspection and Retirement refer to the Rope Retirement Guidelines at: <https://tethrdnation.com/saddle-hunting-101/> or <https://samsonrope.com/resources/rope-care>

### TREE SELECTION

Always select trees that are free of obstacles such as vines or multiple limbs which could cause excessive obstructions. The tree should be from 10"-24" in diameter. Excessively small or large trees can be dangerous to climb. Never climb a tree that is dead, dying, wet, icy, or excessively leaning.

### WARNING

Indicates the inherent dangers and responsibilities the user assumes when using a TETHRD® product.

### MAXIMUM WEIGHT

The maximum weight of the user and their gear using a climbing stick is 300 lbs. DO NOT jump or bounce on the climbing stick. Always attach your climbing lineman's belt or tether to the tree and affix to your TETHRD® Saddle or a full body harness before climbing on your climbing stick.

### WARRANTY

We warrant for one year from purchase date and only to the original retail buyer (Buyer) that our products (Products) are free from defects in material and workmanship. If Buyer discovers a covered defect, Buyer shall deliver the Product to us at the address set forth in this pamphlet. We will replace such Product free of charge. That is the extent of our liability under this Warranty and, upon the expiration of the applicable warranty period, all such liability shall terminate.

### WARRANTY EXCLUSIONS

We do not warrant Products against normal wear and tear, unauthorized modifications or alterations, improper use, improper maintenance, accident,

WARNING

For hunting from an elevated position only. Hunting with a saddle is dangerous. Understand and accept the risks involved before participating. You are responsible for your own actions and decisions. Before using this product, read and understand all instructions and warnings that accompany it and familiarize yourself with its capabilities and limitations. We recommend that every individual seek qualified instruction before use. Never climb a tree without a full body harness that meets the requirements of ASTM F2337. Failure to respect any of these warnings can result in severe injury or death!

ATTACHING THE CLIMBING STICK TO THE TREE

Before attaching the climbing stick to a tree make sure you are wearing an appropriate fall-rated full-body safety harness with your lineman's climbing belt fully secured to the tree and connected to your harness. **NEVER ATTEMPT TO CLIMB A TREE WITHOUT YOUR HARNESS AND A LINEMAN'S CLIMBING BELT.**

FOR RIGHT SIDE STICK ATTACHMENT:

1. While holding the climbing stick (a) against the tree pass the DynaLITE™ Rope (b) around the back side of the tree (Fig. 1.1).
2. Pass the DynaLITE™ Rope below the DynaLOC™ Button (c) and loop it over the top of the DynaLOC™ Button (Fig. 1.2), ensuring the tag end of the DynaLITE™ Rope is passed over the top of the DynaLITE™ Rope. (Fig. 1.3). **NEVER PASS THE TAG END OF THE DYNALITE™ ROPE UNDERNEATH ITSELF DURING THIS STEP (FIG. 1.3)**
3. Firmly pull the tag end of the DynaLITE™ Rope down to tighten the loop around the DynaLOC™ Button. (Fig. 1.4)
4. Feed the DynaLITE™ Rope through the bottom-right notch (d) of the DynaLOC™ Button (Fig. 1.5).
5. Keeping the DynaLITE™ Rope taut, feed the DynaLITE™ Rope through the opposite top-left corner notch (d) of the DynaLOC™ Button. (Fig. 1.6)
6. Once the DynaLITE™ Rope has been fully seated in both notches (d) pull down on the DynaLITE™ Rope to tighten the DynaLITE™ Rope to the DynaLOC™ Button. (Fig. 1.7). **IF THERE IS SLACK IN THE DYNALITE™ ROPE AT THIS POINT REPEAT STEPS 1-5 TO REMOVE SLACK FROM THE DYNALITE™ ROPE.**
7. Feed the DynaLITE™ Rope through the bottom-left notch (d) of the DynaLOC™ Button (Fig. 1.8).
8. Feed the DynaLITE™ Rope through the opposite top-right notch (d) on the DynaLOC™ Button (Fig. 1.9), keeping the DynaLITE™ Rope in front of itself during this process (Fig. 1.10). **DO NOT PASS THE TAG END OF THE DYNALITE™ ROPE UNDERNEATH ITSELF DURING THIS STEP (FIG. 1.10).**
9. Once the DynaLITE™ Rope has been fully seated in the remaining notches pull down firmly on the DynaLITE™ Rope to secure it to the DynaLOC™ Button. (Fig. 1.11, Fig. 1.12) **IF THERE IS SLACK IN THE DYNALITE™ ROPE AT THIS POINT REPEAT ALL PREVIOUS STEPS TO REMOVE SLACK FROM THE DYNALITE™ ROPE.**
10. Secure the tag end of the DynaLITE™ Rope to itself using a half-hitch knot passed around the under side of itself. (Fig. 1.13).
11. Once the DynaLITE™ Rope has been secured to the DynaLOC™ Button press down firmly on the climbing stick. You are now ready to climb using the climbing stick. The DynaLITE™ Rope should form an "X" through all four notches in the DynaLOC™ Button (Fig. 1.14).
12. When installed properly the climbing stick should be secured **TIGHTLY** against the tree and there should be **NO SLACK** in the DynaLITE™ Rope. **IF THERE IS SLACK IN THE DYNALITE™ ROPE AT THIS POINT REPEAT ALL PREVIOUS STEPS TO REMOVE SLACK FROM THE DYNALITE™ ROPE.**
13. The steps above can be mirrored for left side attachment.

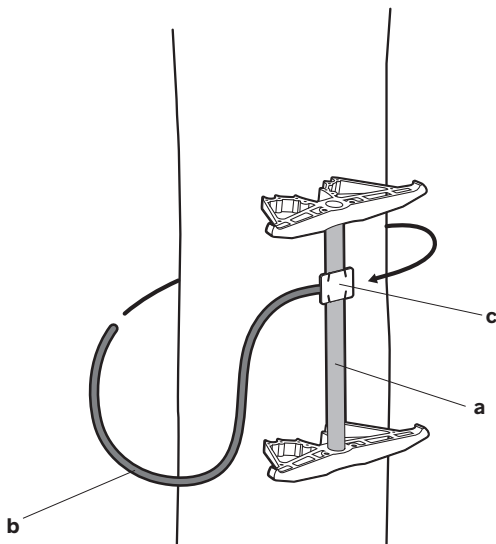

Figure 1.1

If there are any questions, DO NOT use the product and contact TETHRD® for support:

Phone: (612) 605-7782

Email: hello@tethrdnation.com

ATTACHING THE STICK TO THE TREE (RIGHT SIDE OF STICK ATTACHMENT) CONT.

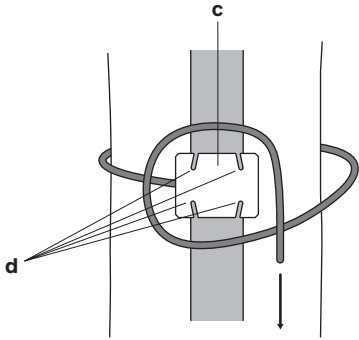

Figure 1.2

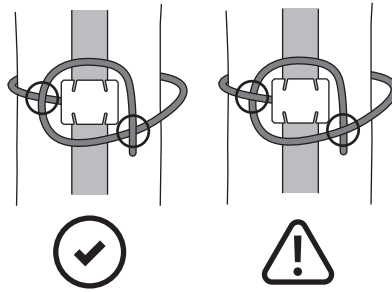

Figure 1.3

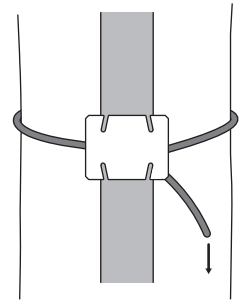

Figure 1.4

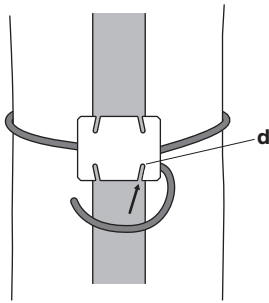

Figure 1.5

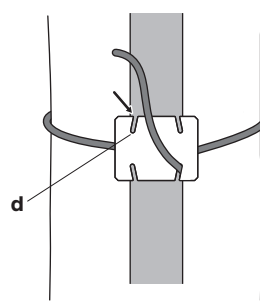

Figure 1.6

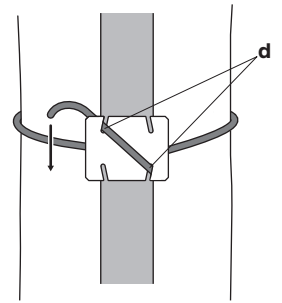

Figure 1.7

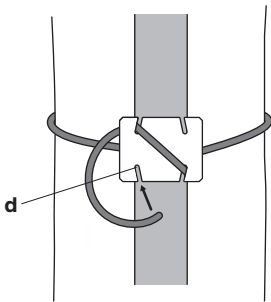

Figure 1.8

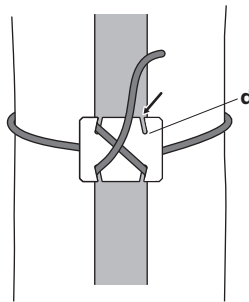

Figure 1.9

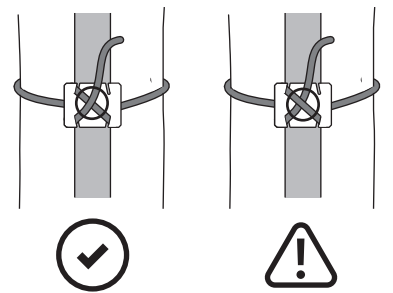

Figure 1.10

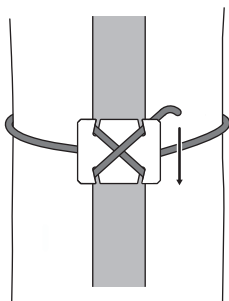

Figure 1.11

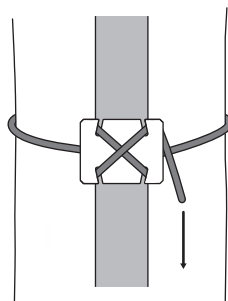

Figure 1.12

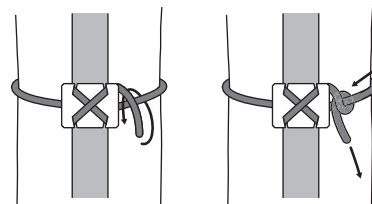

Figure 1.13

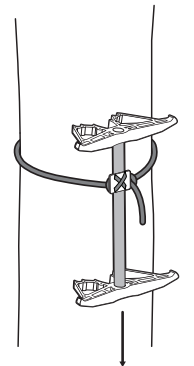

Figure 1.14

## STACKING THE CLIMBING STICK FOR TRANSPORT OR STORAGE

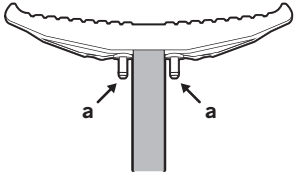

Figure 2.1

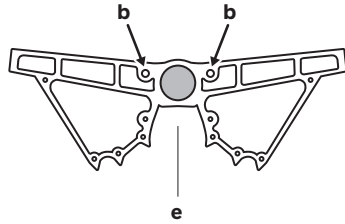

Figure 2.2

Stacking the climbing stick with another climbing stick is a quick and easy process using Tethrd's StickLOC™ technology. Follow the steps below to stack the climbing stick for transport or storage. Stacking the sticks is easiest when stacking one stick on top of another, from bottom to top.

1. Locate the StickLOC™ connectors (**a**) on the bottom of each step (**Fig. 2.1**) and the mating holes (**b**) on the top of each step (**Fig. 2.2**) on the climbing stick (**c**).
2. Placing the climbing sticks next to each other, position the top stick on top of bottom sticks' DynaLOC™ Button (**d**), with the tube of the bottom stick nesting inside the step recess (**e**) from the top stick's steps. (**Fig. 2.3**)
3. Slide the climbing stick down while keeping the StickLOC™ connectors aligned with the mating holes. (**Fig. 2.4**)
4. Press the sticks together firmly. Once the StickLOC™ connectors have been fully seated in the mating holes the climbing stick should be very snug with little to no movement. (**Fig. 2.5**)
5. Repeat the process to continue stacking additional sticks. (**Fig. 2.6**)

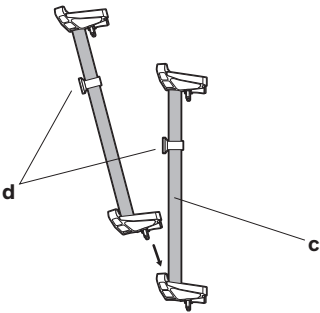

Figure 2.3

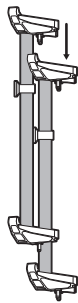

Figure 2.4

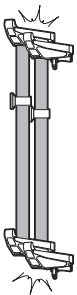

Figure 2.5

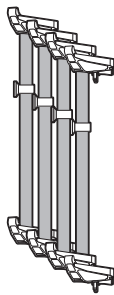

Figure 2.6

## TROUBLESHOOTING

### WARNING

**DO NOT TROUBLESHOOT CLIMBING STICKS WHILE USING OR STANDING ON CLIMBING STICKS.  
MAKE ALL ADJUSTMENTS AT GROUND LEVEL.**

#### ISSUE

#### SOLUTION

DynaLITE™ Rope rope is worn, cut, frayed, damaged or past 2-year service life.



**DO NOT USE.** Contact Customer Service at (612) 605-7782 or email support at [hello@tethrdnation.com](mailto:hello@tethrdnation.com) for assistance.

Climbing stick is dented, bent, cracked or damaged in any way.



**DO NOT USE.** Replace climbing stick.

Missing Parts



**DO NOT USE.** Contact TETHRD® for customer support.

TETHRD® Saddle or Full Body Harness with Lineman's Climbing Belt is unavailable



**DO NOT USE, INSTALL, OR UNINSTALL CLIMBING STICKS.** Remain at ground level.

Problems with TETHRD® Saddle or Full Body Harness with Lineman's Climbing Belt



**DO NOT USE, INSTALL OR UNINSTALL CLIMBING STICKS.** Remain at ground level.

## LIMITED WARRANTY

**THE PURCHASE OF THIS PRODUCT INCLUDES A LIMITED ONE YEAR WARRANTY. WE WARRANT THIS PRODUCT AGAINST ANY MANUFACTURER DEFECTS IN MATERIALS AND WORKMANSHIP FOR PERIOD OF ONE YEAR FROM DATE OF PURCHASE FROM AUTHORIZED RETAILER TO THE ORIGINAL, REGISTERED OWNER . WE WILL REPAIR OR REPLACE ANY PART FOUND DEFECTIVE IF THE UNIT CLAIMED TO BE DEFECTIVE IS RETURNED TO TETHRD® POSTAGE PREPAID, WITHIN WARRANTY PERIOD. CONTACT CUSTOMER SERVICE AT TETHRD® at (612) 605-7782 OR EMAIL SUPPORT HELLO@TETHRDNATION.COM FOR WARRANTY CLAIMS.**

This warranty is void if any product has been subjected to misuse, abuse, and neglect including but not limited to: improper maintenance, failure to follow instructions, improper storage, improper use, misapplication, accident, normal wear, modification, adjustment, or unauthorized repair.

**NO OTHER WARRANTIES WHETHER EXPRESSED OR IMPLIED, INCLUDING WARRANTIES OF MERCHANTABILITY AND FITNESS FOR A PARTICULAR PURPOSE, SHALL APPLY TO THE PRODUCT.**

#### LIMITATION OF LIABILITY

It is expressly understood that our liability for this product, whether due to breach of warranty, negligence, strict liability, or otherwise, is limited to repair of the product as stated above. We will not be liable for any other injury, loss, damage, or expense, whether direct or consequential, including but not limited to loss of use, income, profit, or damage to material from use of this product howsoever caused.

#### SERVICING YOUR PRODUCT

If you need repairs or have warranty issues, contact Customer Service at (612) 605-7782 or email support at [hello@tethrdnation.com](mailto:hello@tethrdnation.com) for assistance.

We reserve the right to make substitutions on warranty coverage for any reason, including but not limited to available parts.



TETHRD® is a team of saddle hunting fanatics with a passionate addiction to whitetail hunting. TETHRD® seeks to accomplish 2 missions: Spread the love for saddle hunting to the sportsman community, and design and engineer the world's best saddle hunting equipment.

TETHRD® evolved from a burning desire to provide quality gear and resources to the saddle hunting community. Because our community is a small niche component of the greater hunting industry, the availability of saddle specific gear and innovation was severely lacking. TETHRD® solved this problem by designing, engineering, and producing the most mobile, stealthy, and safest elevated hunting gear on the planet.

If it doesn't make the saddle hunting community better, we won't do it. Period.

Scan with your smart phone camera app to visit:

TETHRD NATION

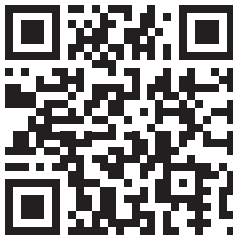

TETHRD NATION YOUTUBE

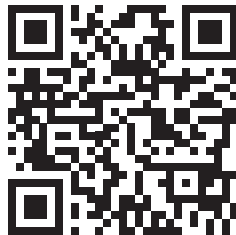

TMA SAFETY GUIDELINES



CLIMBING AID SAFETY

